

A instabilidade da geometria euclidiana

Seminário de coisas legais

Lucas Giraldi Almeida Coimbra

Instituto de ciências matemáticas e computação (ICMC)
Universidade de São Paulo

Novembro, 2022



- ① Curvatura
- ② Espaço das retas orientadas
- ③ Espaço dos triângulos
- ④ Referências

- ① Curvatura
- ② Espaço das retas orientadas
- ③ Espaço dos triângulos
- ④ Referências

Superfícies

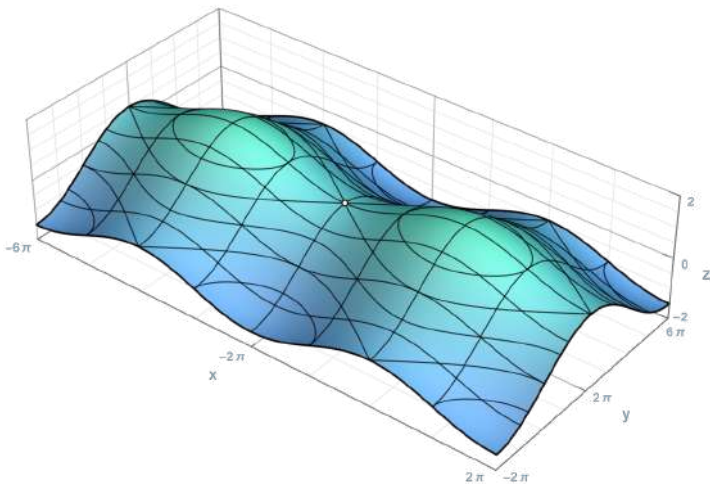

Superfícies

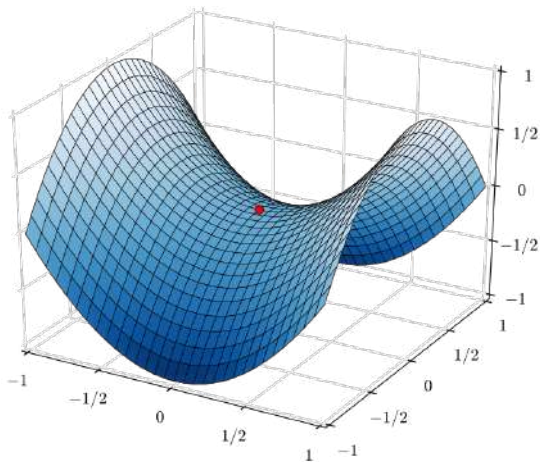

Superfícies

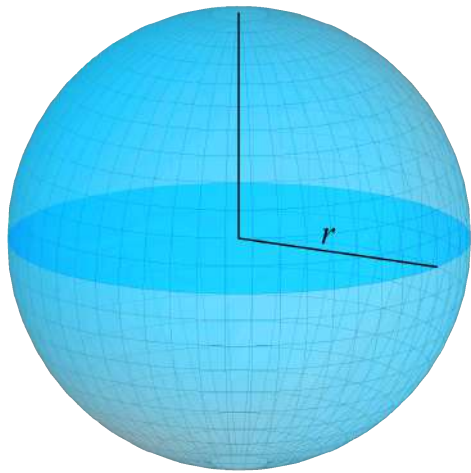

Superfícies

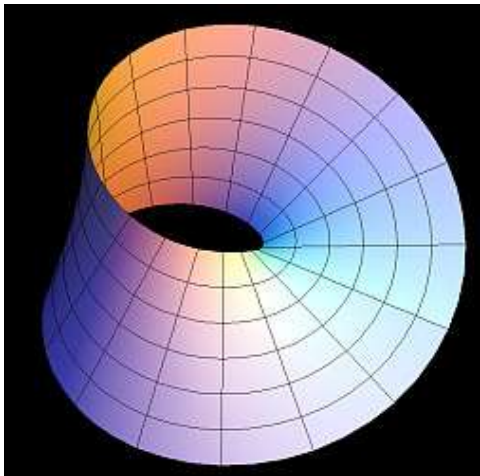

Curvatura

$K < 0$:

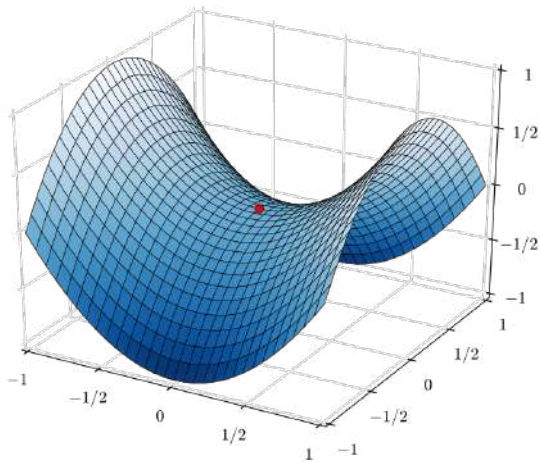

Curvatura

$K = 0$:

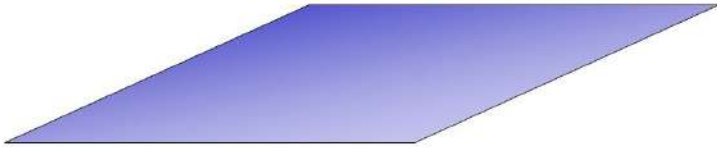

Curvatura

$$K > 0:$$

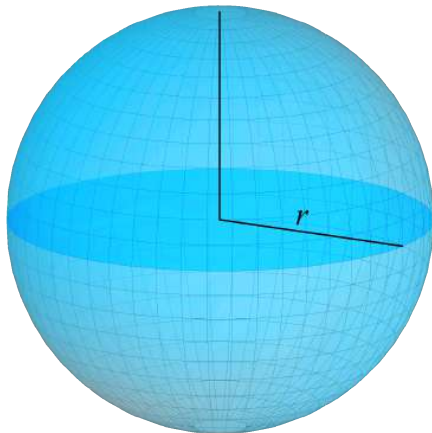

- ① Curvatura
- ② Espaço das retas orientadas
- ③ Espaço dos triângulos
- ④ Referências

Orientação

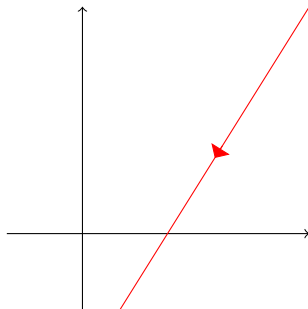
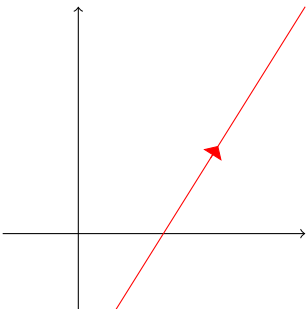

Retas

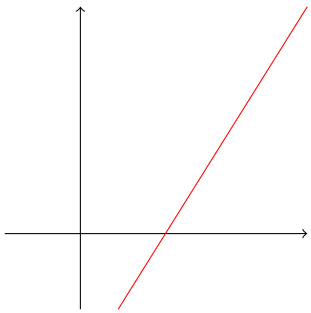

Retas

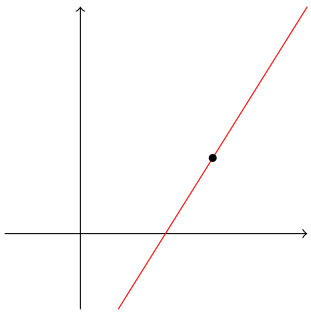

Retas

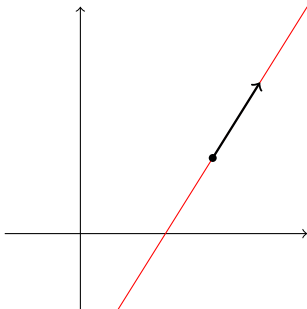

Retas

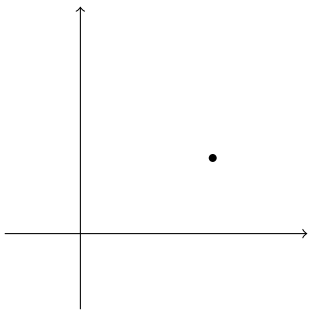

Retas

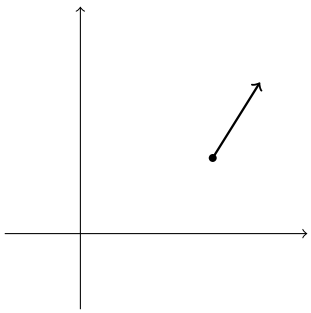

Retas

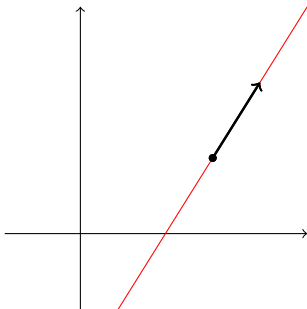

Redundâncias

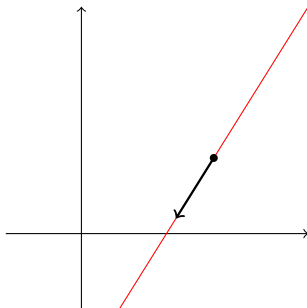
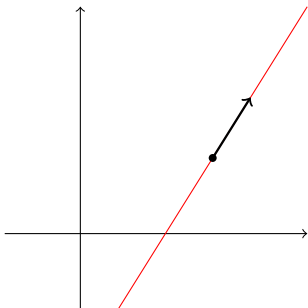

Redundâncias

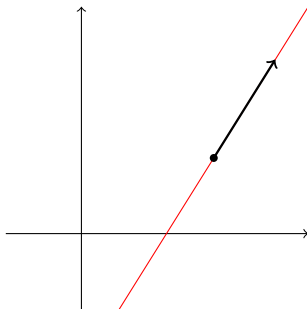
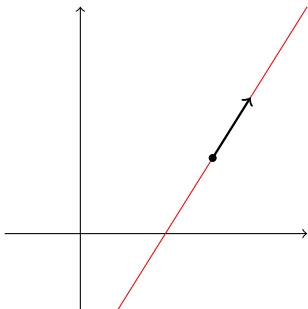

Tirando redundâncias

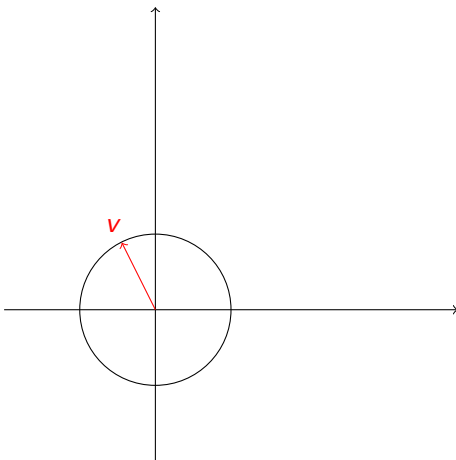

Mais redundâncias

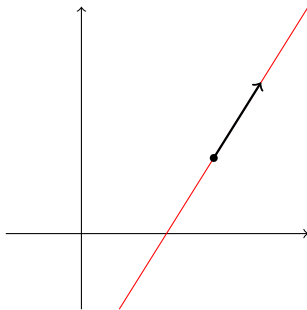
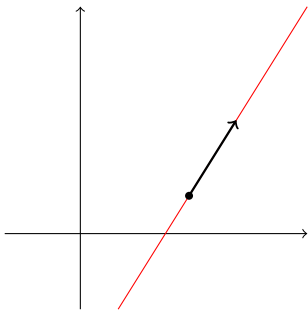

Tirando redundâncias

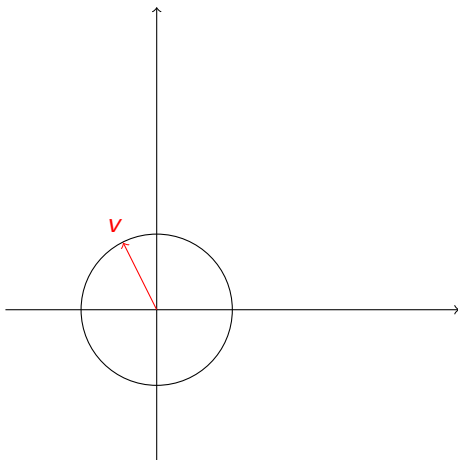

Tirando redundâncias

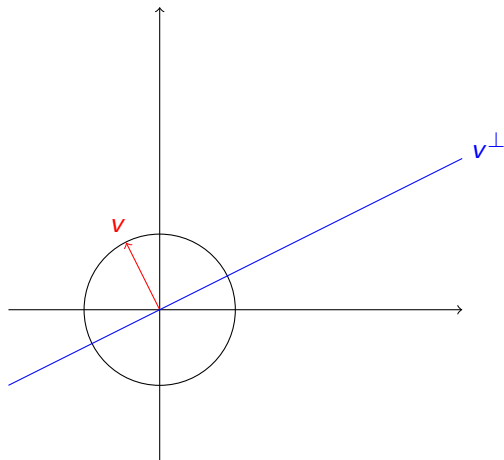

Tirando redundâncias

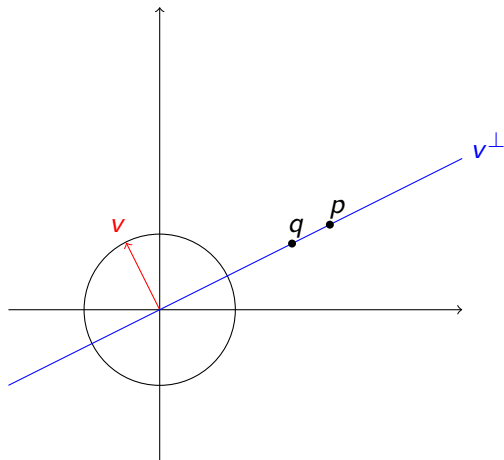

Tirando redundâncias

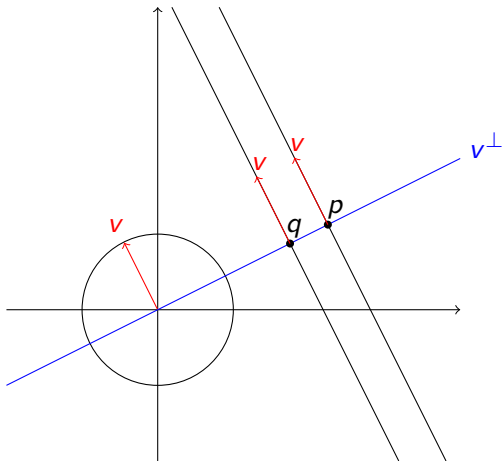

Conclusão

Retas \longleftrightarrow pares (v, p) , onde v é um vetor que está no círculo de raio 1, e p é um ponto que está na reta perpendicular a v .

Conclusão

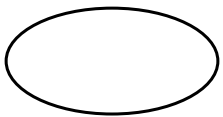

Conclusão

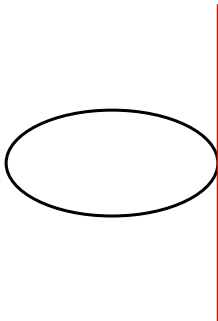

Conclusão

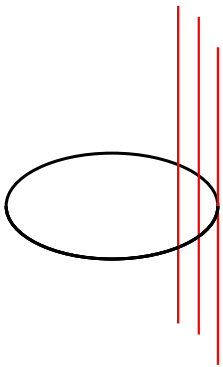

Conclusão

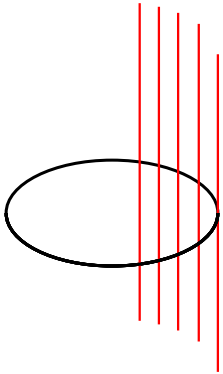

Conclusão

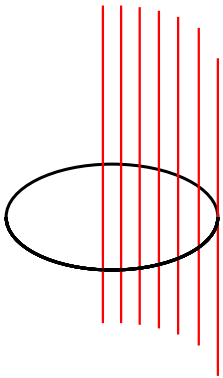

Conclusão

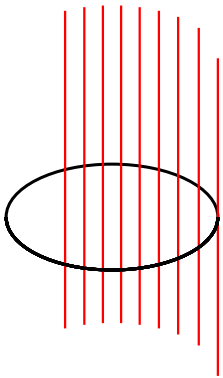

Conclusão

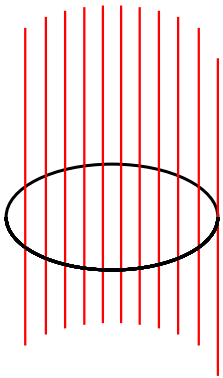

Conclusão

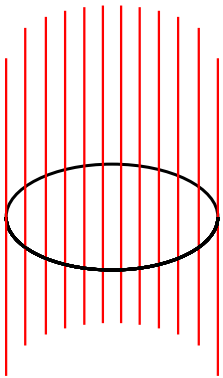

Conclusão

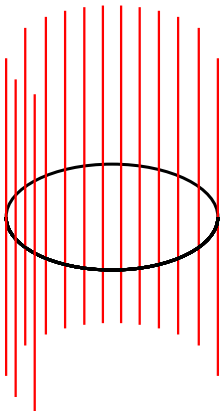

Conclusão

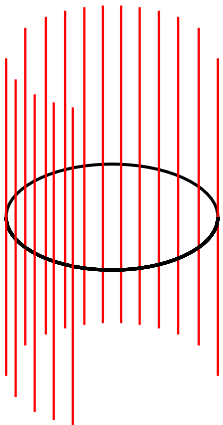

Conclusão

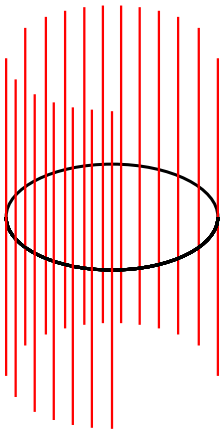

Conclusão

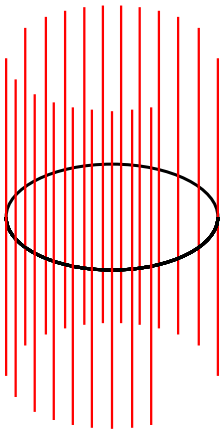

Conclusão

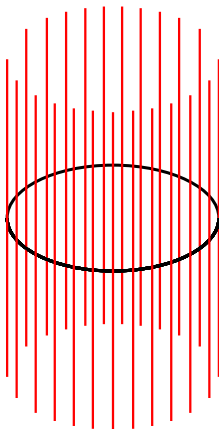

CILINDRO!

- ① Curvatura
- ② Espaço das retas orientadas
- ③ Espaço dos triângulos
- ④ Referências

O semiplano

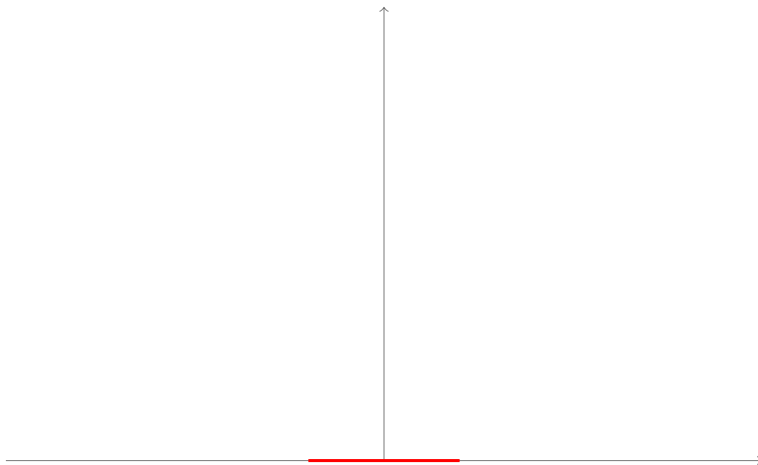

Equilátero

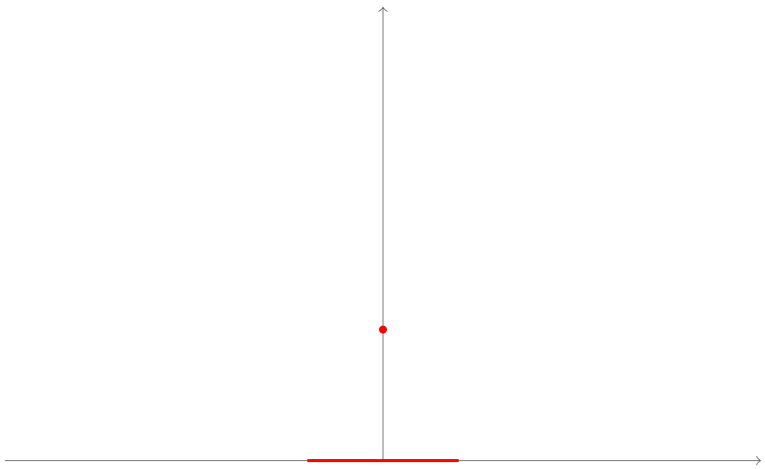

Equilátero

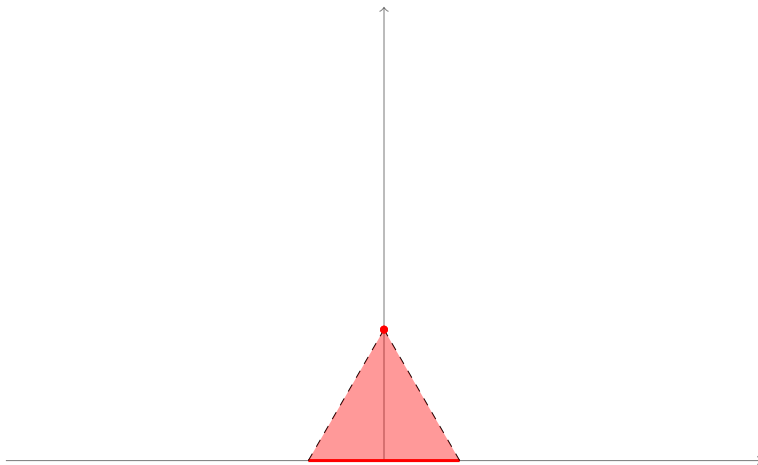

Retângulos

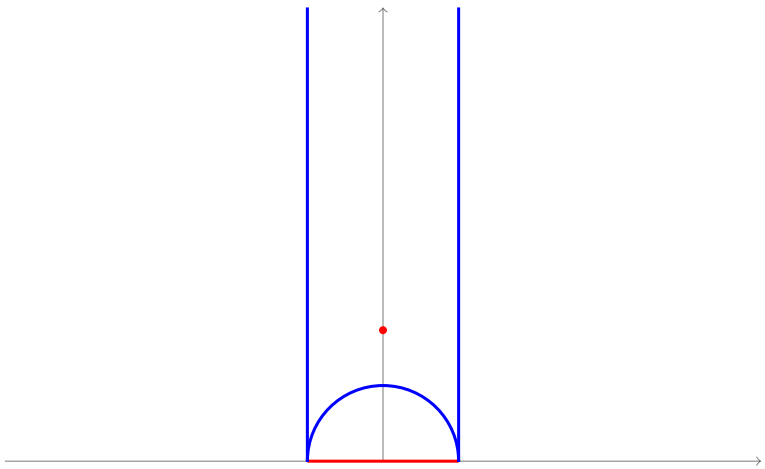

Retângulos

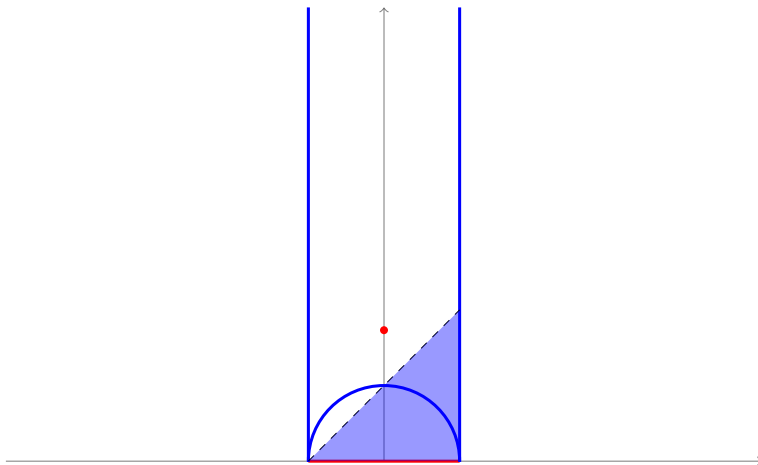

Retângulos

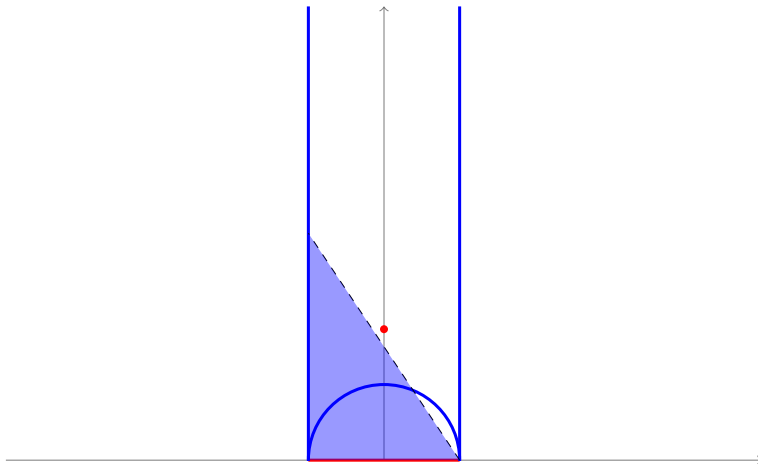

Retângulos

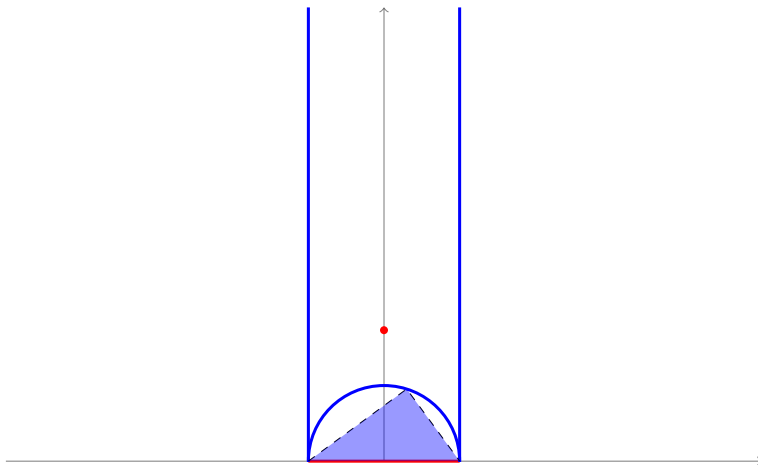

Isósceles

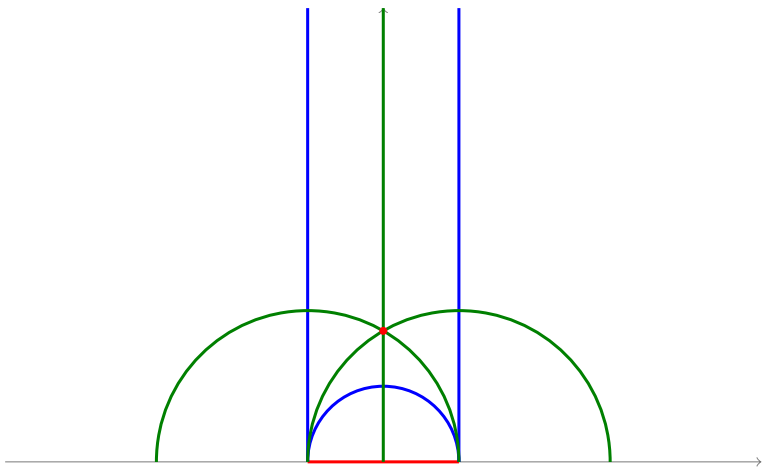

Isósceles

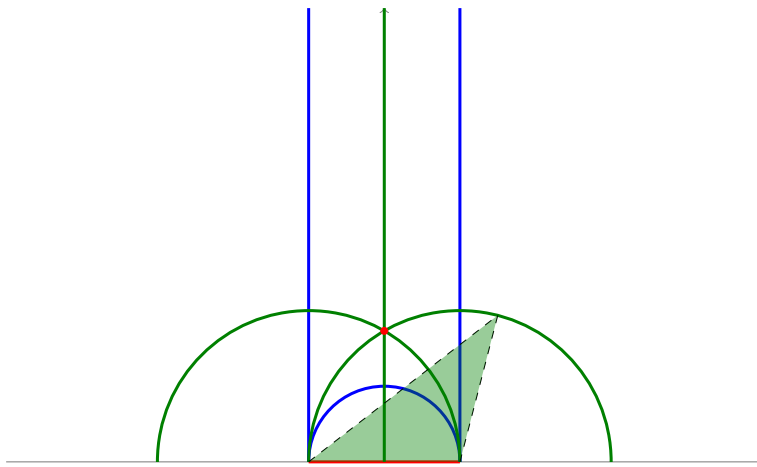

Isósceles

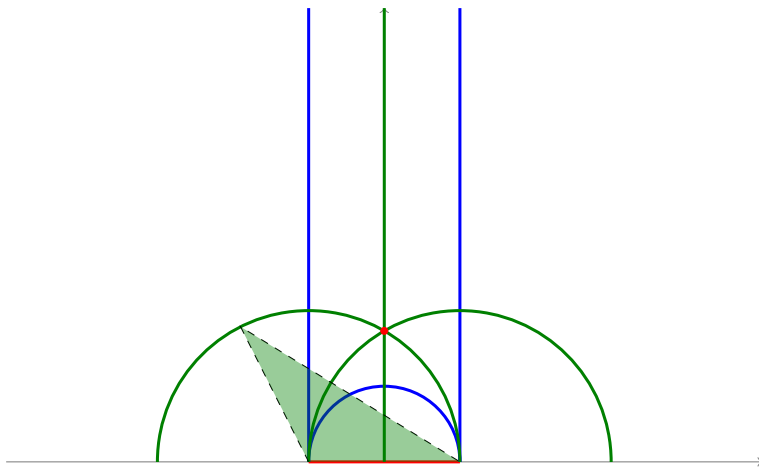

Isósceles



Figura completa



Curiosidade: acutângulos e obtusângulos

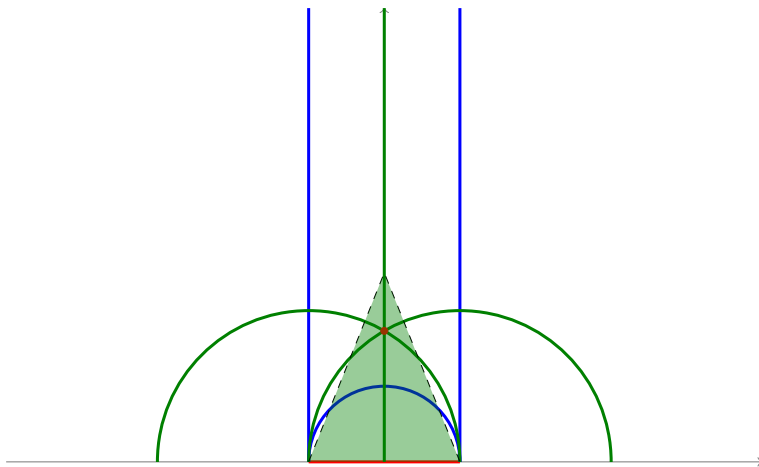
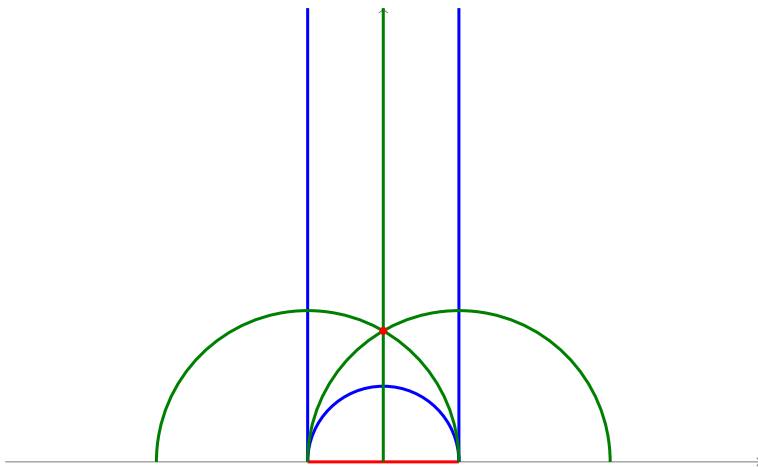
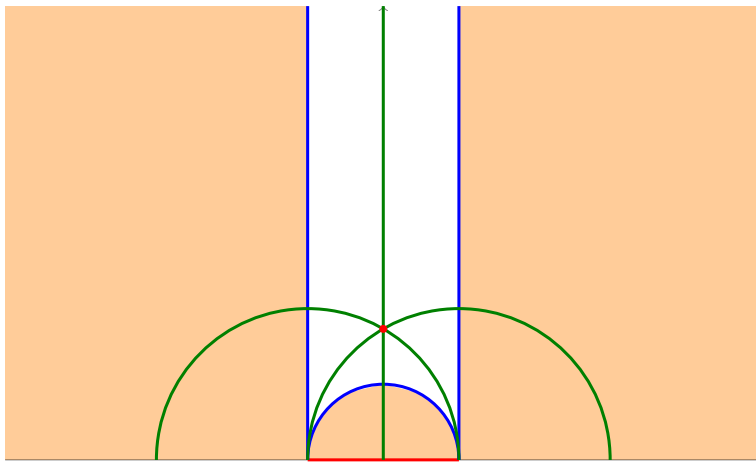

Redundâncias

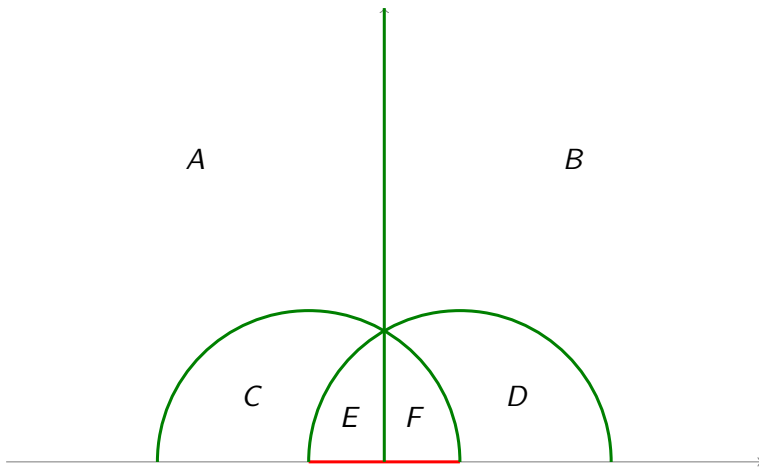

Redundâncias

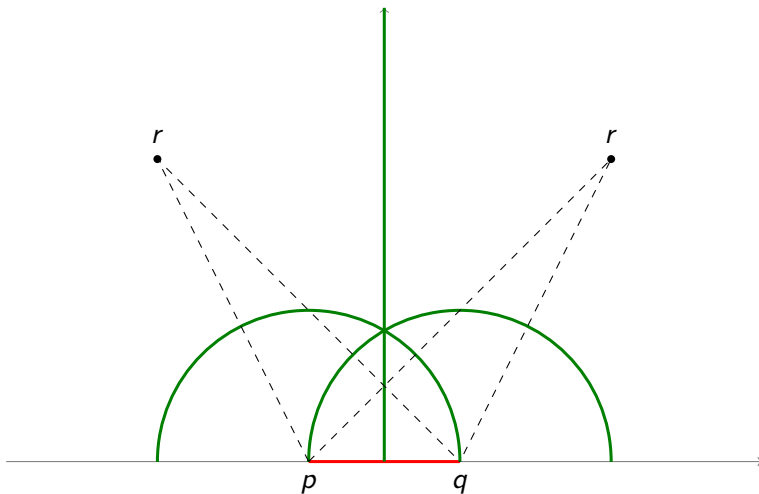

Redundâncias

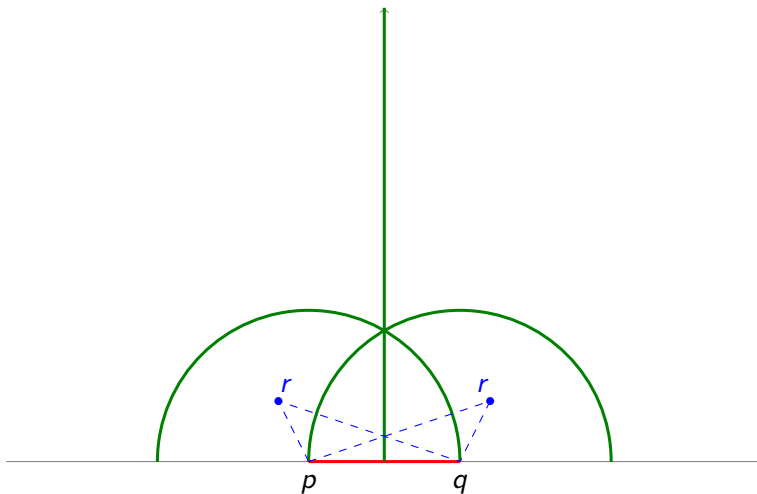

Redundâncias

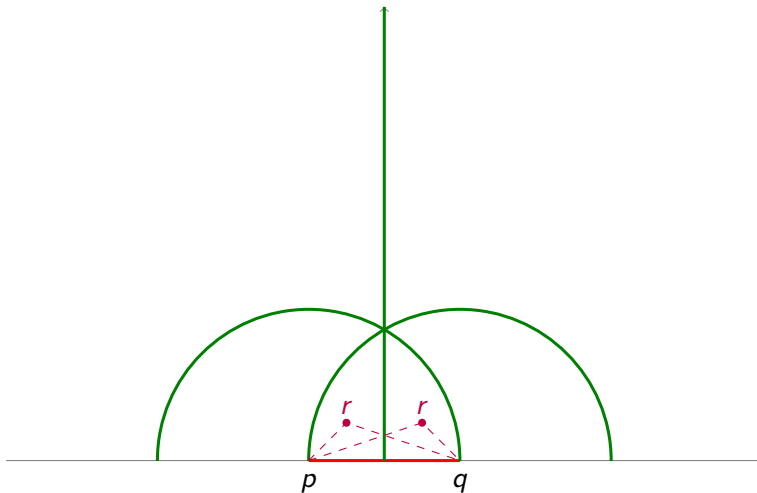

Redundâncias

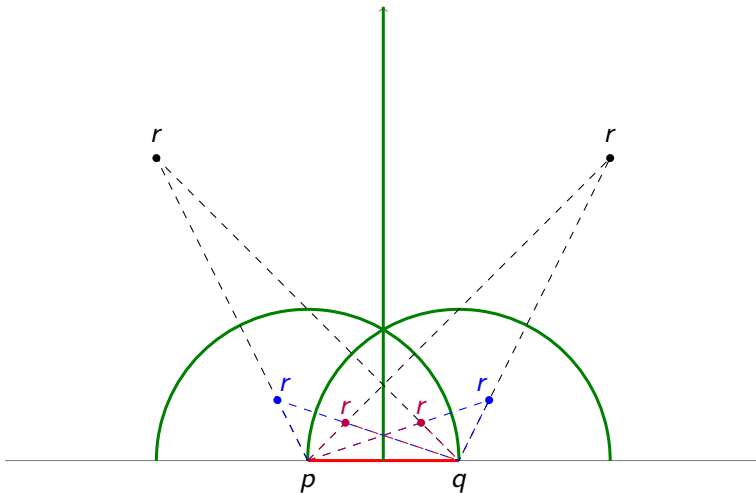

Cosseno hiperbólico

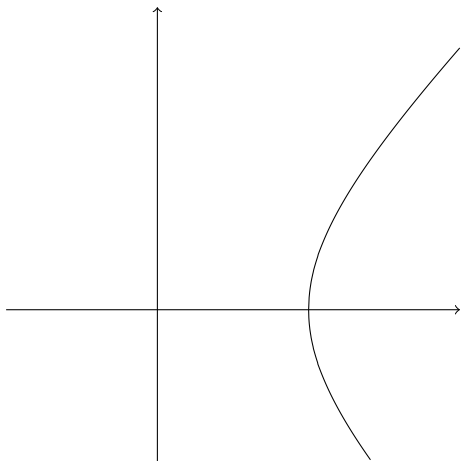

Cosseno hiperbólico

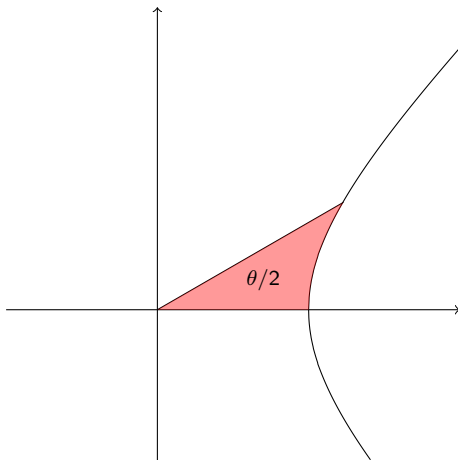

Cosseno hiperbólico

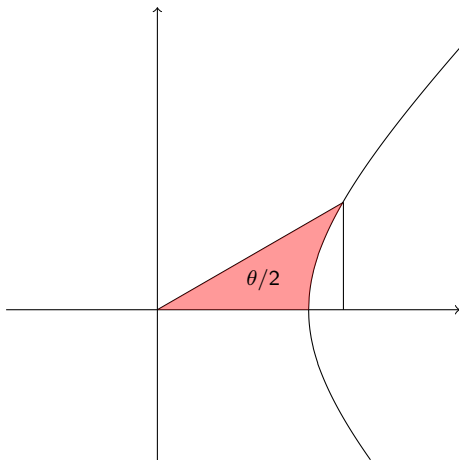

Cosseno hiperbólico

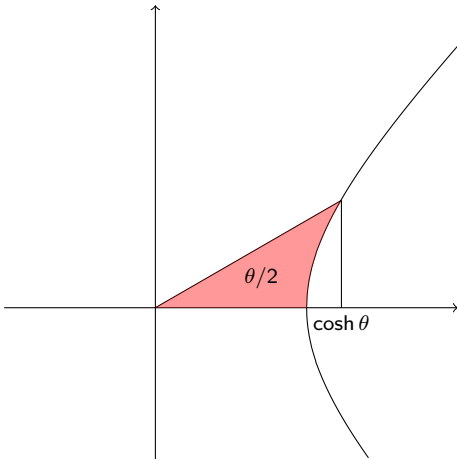

Distâncias

Se $x = (x_1, x_2)$ e $y = (y_1, y_2)$, então

$$d_E(x, y) = \sqrt{|x_1 - y_1|^2 + |x_2 - y_2|^2}$$

$$d_H(x, y) = \cosh^{-1} \left(1 + \frac{d_E(x, y)^2}{2x_2y_2} \right)$$

Redundâncias

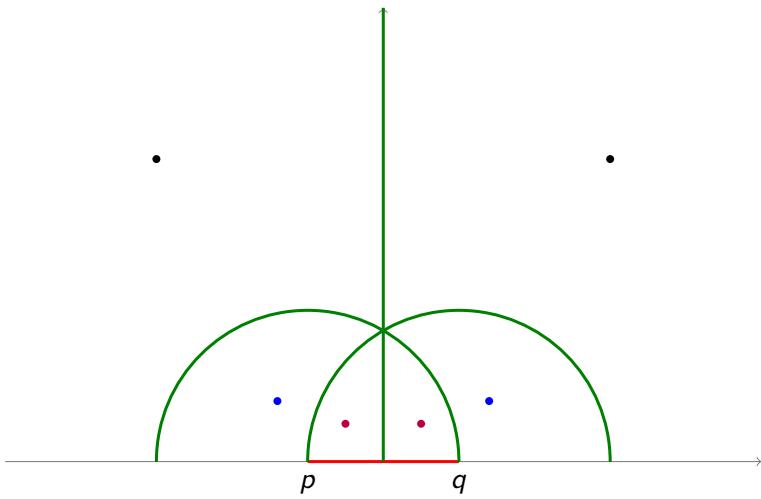

Redundâncias

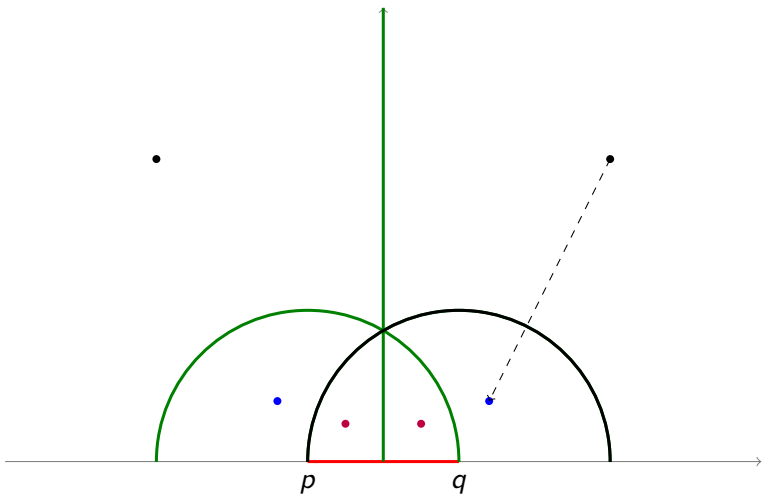

Redundâncias

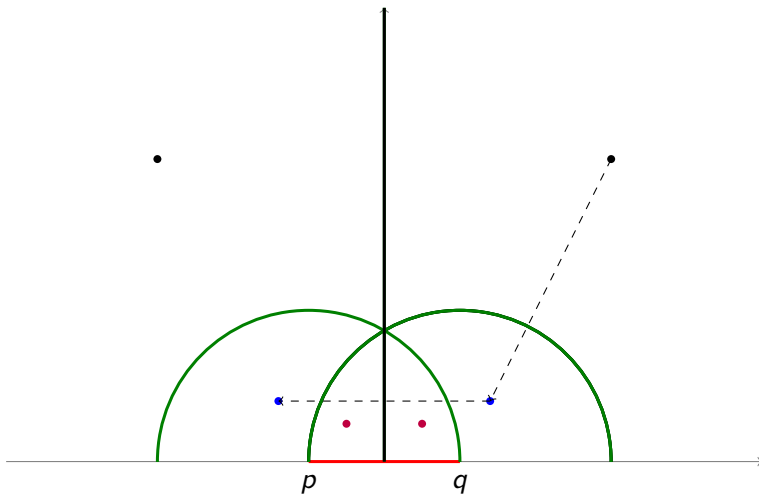

- ① Curvatura
- ② Espaço das retas orientadas
- ③ Espaço dos triângulos
- ④ Referências

Referências

1 2 3 4

